

HOT-579
Pentium™ processor
Based PCI MAINBOARD
User's Manual

FCC Notice:

This equipment has been tested and found to comply with the limits for a Class B digital device, pursuant to Part 15 of FCC Rules. These limits are designed to provide reasonable protection against harmful interference in a residential installation. This equipment generates, uses and can radiate radio frequency energy. If not installed and used properly, in strict accordance with the manufacturer's instructions, may cause harmful interference to radio communications. However, there is no guarantee that interference will not occur in a particular installation. If this equipment does cause interference to radio or television reception, which can be determined by turning the equipment off and on, the user is encouraged to try to correct the interference by one or more of the following measures :

Reorient or relocate the receiving antenna.

Increase the separation between the equipment and receiver.

Connect the equipment into an outlet on a circuit different from that to which the receiver is connected.

Consult the dealer or an experienced radio/television technician for help and for additional suggestions.

The user may find the following booklet prepared by the Federal Communications Commission helpful "How to Identify and Resolve Radio-TV Interference Problems." This booklet is available from the U.S. Government Printing Office, Washington, DC 20402, Stock 004-000-00345-4

FCC Warning

The user is cautioned that changes or modifications not expressly approved by the manufacturer could void the users authority to operate this equipment.

Note : In order for an installation of this product to maintain compliance with the limits for a Class B device, shielded cables and power cord must be used.

CE Notice:

Following standards were applied to this product, in order to achieve compliance with the electromagnetic compatibility :

- Immunity in accordance with EN 50082-1: 1992
- Emissions in accordance with EN 55022: 1987 Class B.

NOTICE

Copyright 1997.

All Right Reserved

Manual Ver 1.1

All information, documentation, and specifications contained in this manual are subject to change without prior notification by the manufacturer.

The author assumes no responsibility for any errors or omissions which may appear in this document nor does it make a commitment to update the information contained herein.

TRADEMARKS

All the brands and product names referred to in this manual are trademarks or registered trademarks of their respective holders.



TABLE OF CONTENTS

| | |
|--|-----------|
| PREFACE | 3 |
| CHAPTER 1 FEATURES | 4 |
| Accessories of HOT-579 | 6 |
| CHAPTER 2 HARDWARE CONFIGURATION | 7 |
| Jumper Setting | 7 |
| CPU Clock Configurations - JP4 ~ JP6 and JP11 ~ JP14 | 8 |
| System Clock and CPU Multiplier on HOT-579 | 9 |
| CPU Voltage Configuration - JP33 | 10 |
| Flash EEPROM Vpp - JP17 | 11 |
| Clear CMOS - JP19 | 11 |
| Power Supply Type Select - JP31 | 11 |
| Connectors & Sockets | 12 |
| CHAPTER 3 MEMORY CONFIGURATION | 14 |
| CHAPTER 4 FLASH UTILITY | 16 |
| CHAPTER 5 BIOS SETUP | 18 |
| Main Menu | 19 |
| Standard CMOS Setup | 21 |
| BIOS Features Setup | 23 |
| Chipset Features Setup | 25 |
| Power Management Setup | 27 |
| PCI Configuration Setup | 29 |
| Integrated Peripherals | 31 |
| Password Setting | 33 |

P

PREFACE

HOT-579 mainboard is a highly integrated IBM PC/AT compatible system board. The design will accept AMD K5, K6, Intel Pentium P54C, Pentium MMX, IDT-C6 and Cyrix/IBM 6x86, 6x86L, 6x86MX processors and also features high-performance pipelined burst secondary cache memory support with size of 1024KB or 512KB. The memory subsystem is designed to support up to 512 MB of EDO RAM, Standard Fast Page DRAM and SDRAM in standard 72-pin SIMM socket and 168-pin 3.3 V DIMM socket.

HOT-579 provides a new level of I/O integration. VIA580VPX chipset provides increased integration and improved performance over other chipset designs.

The VIA580VPX chipset provides an integrated Bus Mastering IDE controller with two high performance Ultra 33 DMA IDE interfaces for up to four IDE devices.

The onboard I/O controller provides the standard PC I/O functions: floppy interface, two FIFO serial ports, an IrDA device port and a SPP/EPP/ECP capable parallel port.

Up to four PCI local bus slots provide a high bandwidth data path for data-movement intensive functions such as graphics, and up to three ISA slots complete the I/O function.

The HOT-579 provides the foundation for cost effective, high performance, highly expandable platforms, which deliver the latest in Pentium processor and I/O standard.

1

FEATURES

The HOT-579 Mainboard is carefully designed for the demanding PC user who wants high performance and many intelligent features in a compact package:

Chipset:

Features VIA580VPX Chipset with I/O subsystems.

CPU Support:

AMD K6 166~266 MHz, K5 PR75~PR166,
Intel Pentium 75~200 MHz, Pentium MMX 166~233 MHz,
Cyrix/IBM 6x86 P120+~P166+, 6x86L P166+, 6x86MX PR166~PR266,
IDT-C6 150~200MHz.

Secondary Cache:

Onboard 1024KB or 512KB Pipelined Burst Cache.

Versatile Memory Supports:

Equipped with four SIMM sockets to support (4, 8, 16, 32, 64 and 128MB) 72-pin EDO or FP memory modules and two DIMM sockets to (8, 16, 32, 64 or 128MB) 168-pin SDRAM memory modules up to 256 MB.

PCI and ISA Expansion Slots:

Provides four 32-bit PCI slots and three 16-bit ISA slots.

Onboard I/O Chip:

Provides one Floppy port; one optional PS/2 mouse connector; two high-speed UART compatible serial ports and one parallel port with ECP and EPP capabilities. Serial Port 2 can also be directed from COM2 to the Infrared Module for wireless connections.

Onboard PCI Bus Master IDE Controller:

Two Ultra DMA/33 Bus Master IDE Ports supports four IDE devices up to 33 MB/sec IDE transfers and supports Enhanced PIO Modes 3 and 4 and Bus Master IDE DMA Mode 2 devices.

Onboard 12-pin AT and 20-pin ATX Power Supply:

Provides AT and ATX power connector onboard.
ATX power supports soft-on/off function.

System BIOS:

Provides licensed Award V4.51PG BIOS on Flash EEPROM.
Supports Green PC, DMI and Bundled with Symbios Login(NCR) SDCM V4.0 SCSI BIOS.

ACPI:

Support ACPI (Advanced Configuration and Power Interface) function. ACPI provide more Energy Saving Features for the future operating system supporting OS Direct Power Management (OSPM) functionality.

Board Size:

3/4 baby AT compact size 220mm x 235mm.

ACCESSORIES OF HOT-579

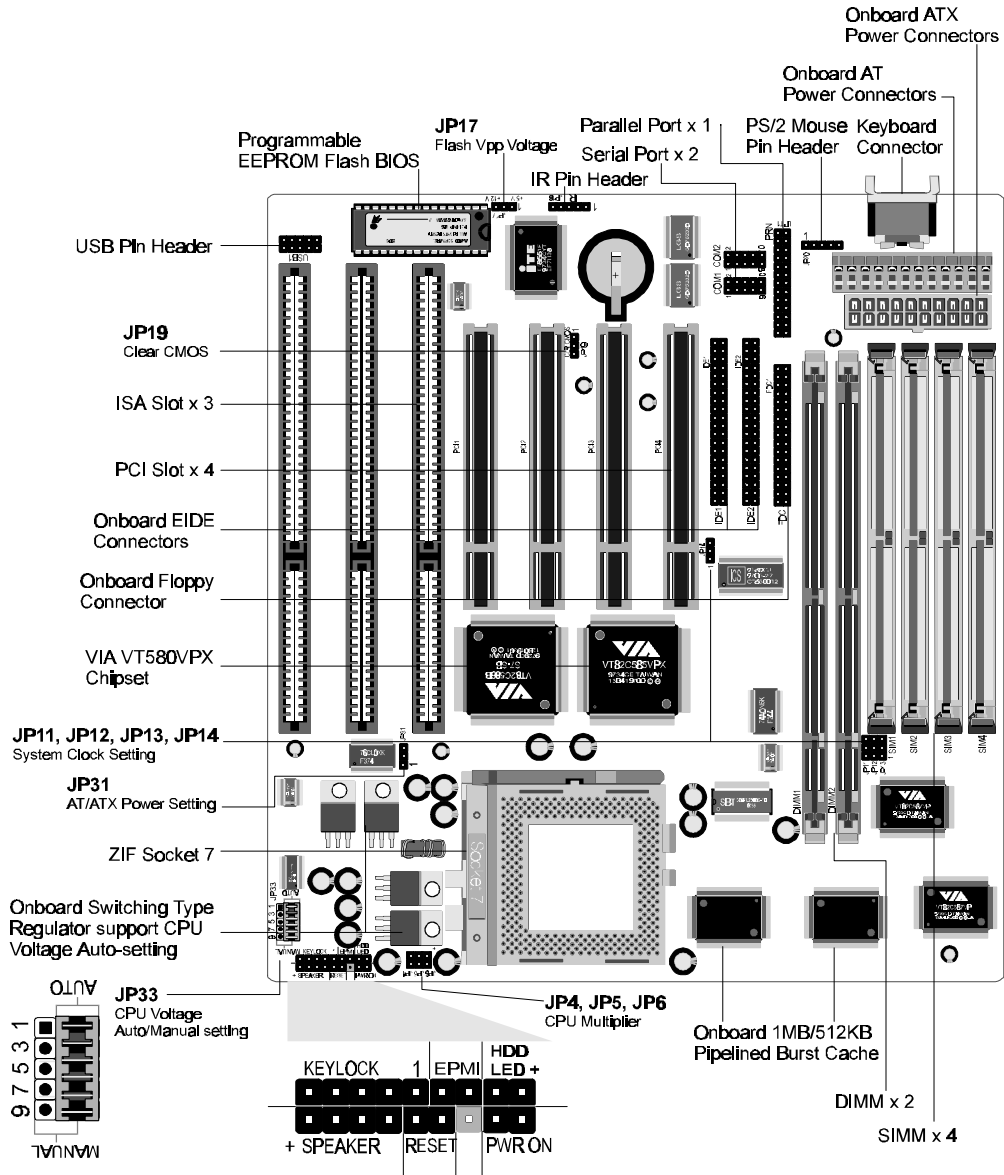

2

HARDWARE CONFIGURATION

Jumper Setting

Jumper pin headers show on right side are used to configure system clock, CPU multiplier and CPU voltages.

System Clock - JP11, JP12 and JP13





JP11, JP12 and JP13 are 3-pins header jumper which is used to adjust System Clock from 50MHz to 83 MHz.

CPU Multiplier - JP4, JP5 and JP6

JP4, JP5 and JP6 are 2-pins header jumper which is used to adjust CPU core multiplier from 1.5X to 5.5X.

CPU Voltages - JP33

JP33 is used to adjust onboard voltages output from Switching type regulators to CPU by inserting or removing mini jumper from pin headers.

Those hardware settings are made through the use of jumper caps to connect jumper pins on the main board. The jumpers will be shown graphically such as  to connect pins 3&4 and 5&6, and  to connect pins 1&2 and 3&4 for six pin jumpers. Jumpers will be shown graphically such as  to connect pins 2&4 and  to connect pins 3&4 for four pin jumpers.

Jumpers with two pins will be shown as  for Short (On) and  for Open (Off). To connect the pins, simply place a plastic jumper cap over the two pins as diagramed.

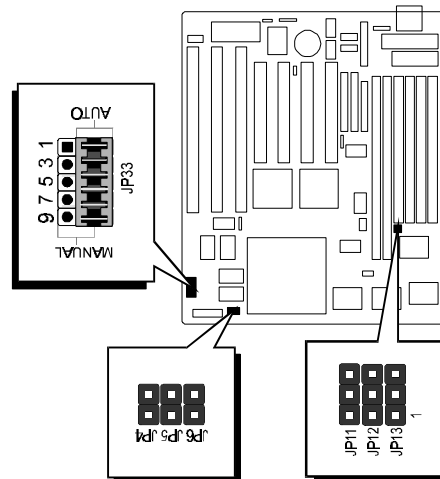

CPU Clock Configuration - JP4 ~ JP6 and JP11 ~ JP13

| Processor | Speed | System Clock | Multiplier | Vcore/Vio |
|------------------------|---------|--------------|------------|------------------------------|
| Intel Pentium P55C MMX | 233 MHz | 66 MHz | 3.5 x | 2.8V / 3.3V |
| | 200 MHz | 66 MHz | 3 x | 2.8V / 3.3V |
| | 166 MHz | 66 MHz | 2.5 x | 2.8V / 3.3V |
| Intel Pentium P54C | 200 MHz | 66 MHz | 3 x | 3.3V |
| | 166 MHz | 66 MHz | 2.5 x | 3.3V |
| | 150 MHz | 60 MHz | 2.5 x | 3.3V |
| | 133 MHz | 66 MHz | 2 x | 3.3V |
| | 120 MHz | 60 MHz | 2 x | 3.3V |
| | 100 MHz | 66 MHz | 1.5 x | 3.3V |
| | 90 MHz | 60 MHz | 1.5 x | 3.3V |
| AMD-K6 | 266 MHz | 66 MHz | 4 x | 2.2V / 3.3V |
| | 233 MHz | 66 MHz | 3.5 x | 3.2V / 3.3V (2.2V / 3.3V) |
| | 200 MHz | 66 MHz | 3 x | 2.9V / 3.3V |
| | 166 MHz | 66 MHz | 2.5 x | 2.9V / 3.3V |
| AMD-K5 | PR166 | 66 MHz | 1.75 x | 3.52V |
| | PR133 | 66 MHz | 1.5 x | 3.52V |
| | PR120 | 60 MHz | 1.5 x | 3.52V |
| | PR100 | 66 MHz | 1.5 x | 3.52V |
| | PR90 | 60 MHz | 1.5 x | 3.52V |
| | PR75 | 50 MHz | 1.5 x | 3.52V |
| Cyrix/IBM 6x86MX | PR266 | 66 MHz | 3.5 x | 2.9V / 3.3V |
| | PR233 | 66 MHz | 3 x | 2.9V / 3.3V |
| | PR200 | 66 MHz | 2.5 x | 2.9V / 3.3V |
| | PR166 | 60 MHz | 2.5 x | 2.9V / 3.3V |
| Cyrix/IBM 6x86L | P166+ | 66 MHz | 2 x | 2.8V / 3.3V |
| | P150+ | 60 MHz | 2 x | 2.8V / 3.3V |
| Cyrix/IBM 6x86 | P166+ | 66 MHz | 2 x | 3.52V |
| | P150+ | 60 MHz | 2 x | 3.52V |
| | P133+ | 55 MHz | 2 x | 3.52V |
| | P120+ | 50 MHz | 2 x | 3.52V |
| IDT-C6 | 150MHz | 60 MHz | 2.5 x | 3.52V |
| | 180MHz | 60 MHz | 3 x | 3.52V |
| | 200MHz | 66 MHz | 3 x | 3.52V |

Table 2-1

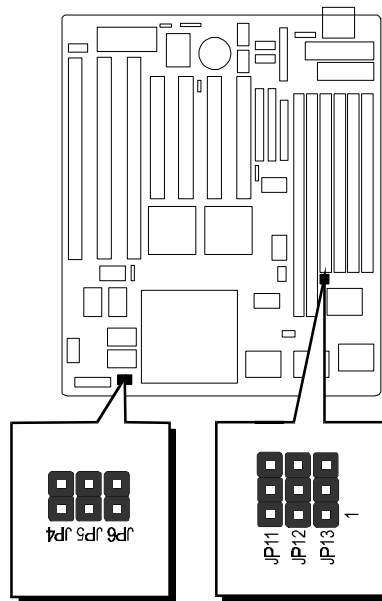

System Clock and CPU Multiplier on HOT-579

For whom like to set up system manually, listed tables show all the System Clock and CPU Multiplier that HOT-579 can offer.

Table 2-2 shows the System Clock from 50 MHz to 83 MHz.

Table 2-3 shows CPU Multiplier from 1.5X to 5.5X.

Note: Since PCI clock is half of system clock, 75MHz and 83MHz system clocks may cause PCI clock beyond PCI specification.

| System Clock | JP11 JP12 JP13 | PCI Clock |
|--------------|--|-----------|
| 50 MHz | JP11: 2 - 3 On JP12: 2 - 3 On JP13: 2 - 3 On | 25 MHz |
| 55 MHz | JP11: 2 - 3 On JP12: 1 - 2 On JP13: 2 - 3 On | 27.5 MHz |
| 60 MHz | JP11: 1 - 2 On JP12: 2 - 3 On JP13: 2 - 3 On | 30 MHz |
| 66 MHz | JP11: 2 - 3 On JP12: 2 - 3 On JP13: 1 - 2 On | 33 MHz |
| 75 MHz | JP11: 1 - 2 On JP12: 1 - 2 On JP13: 2 - 3 On | 37.5 MHz |
| 83 MHz | JP11: 2 - 3 On JP12: 1 - 2 On JP13: 1 - 2 On | 41.5 MHz |

Table 2-2

| Multiplier | JP4 JP5 JP6 | Multiplier | JP4 JP5 JP6 |
|------------|----------------------------------|------------|---------------------------------|
| 1.5 x | JP4: Off JP5: Off JP6: Off | 4 x | JP4: On JP5: Off JP6: On |
| 2 x | JP4: Off JP5: Off JP6: On | 4.5 x | JP4: On JP5: On JP6: On |
| 2.5 x | JP4: Off JP5: On JP6: On | 5 x | JP4: On JP5: On JP6: Off |
| 3 x | JP4: Off JP5: On JP6: Off | 5.5 x | JP4: On JP5: Off JP6: Off |
| 3.5 x | JP4: Off JP5: Off JP6: Off | | |

Table 2-3

CPU Voltage Configuration - JP33











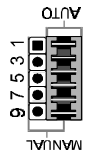





| Voltage | JP33 | Voltage | JP33 | Voltage | JP33 |
|--------------|---|---------|---|---------|---|
| Auto-setting |  | 3.1 V |  | 2.5 V |  |
| |  | 3.0 V |  | 2.4 V |  |
| 3.52 V |  | 2.9 V |  | 2.3 V |  |
| 3.4 V |  | 2.8 V |  | 2.2 V |  |
| 3.3 V |  | 2.7 V |  | 2.1 V |  |
| 3.2 V |  | 2.6 V |  | | |

Table 2-4



Flash EEPROM Vpp - JP17

HOT-579 mainboard supports two types of Flash EEPROM: 5 volt and 12 volt. By setting up jumper JP17, the main board can use both 5V or 12V flash EEPROM with new system BIOS files as they come available.

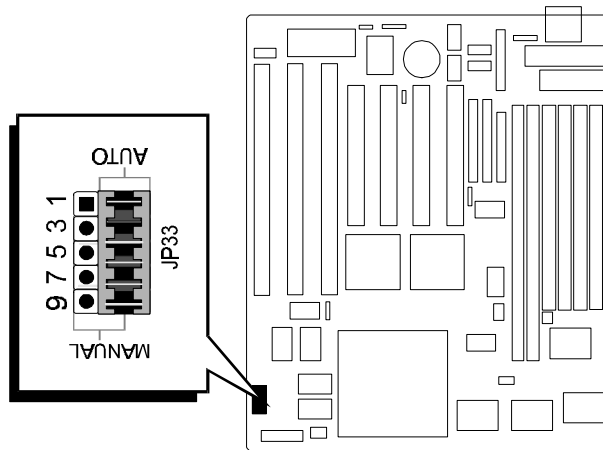
JP17 Pin 2-3 Close for 12V Flash EEPROM

JP17 Pin 1-2 Close for 5V Flash EEPROM

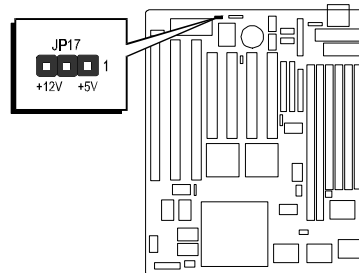

Clear CMOS - JP19

HOT-579 mainboard supports jumper JP19 for discharging mainboard's CMOS memory.

This jumper can clear the CMOS data stored in the sub-system chip. To clear the CMOS data please follow listed steps:

- 1) Turn off the PC,
- 2) Remove the jumper cap from JP19 pin 1-2,
- 3) Insert the jumper cap to JP19 pin 2-3 for a brief while,
- 4) Remove the jumper cap from JP19 pin 2-3,
- 5) Reinsert the jumper cap to JP19 pin 1-2,
- 6) Turn on the PC.

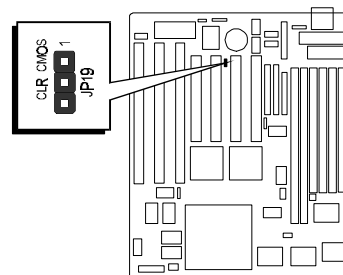

Power Supply Type Select

HOT-579 provide both AT and ATX power connector on-board, AT and ATX power supply are available on HOT-579. Jumper JP31 is used to set what type of power supply is plugged to the main board.

| Power Supply Type | Outline | JP31 |
|-------------------|---------|------|
| 12-Pin AT Type | | |
| 20-Pin ATX Type | | |

Table 2-5

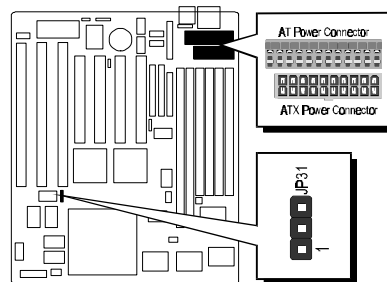

Connectors & Sockets

| ITEM | FUNCTION | ITEM | FUNCTION |
|----------------|--------------------------------------|---------|--|
| SIM 1, 2, 3, 4 | On-board SIMM sockets | USB1 | Universal Serial Bus (USB) Connectors |
| DIMM 1, 2 | On-board 3.3V DIMM sockets | IR | Infra-Red Connectors |
| PCI 1, 2, 3, 4 | On-board PCI Slots | HDD LED | On-board Enhanced IDE R/W LED Connector |
| SL 1, 2, 3 | On-board ISA Slots | RESET | Hardware Reset Switch Connector |
| IDE1 | On-board PCI Primary IDE Connector | KEYLOCK | Power LED and Keylock Connector |
| IDE2 | On-board PCI Secondary IDE Connector | SPEAKER | PC Speaker Connector |
| FDC | On-board Floppy Controller Connector | CNA1 | ATX Power Supply Connector |
| PRN | On-board Parallel Port Connector | CN9 | AT Power Supply Connector |
| COM1 | On-board Serial Port-1 Connector | PWR ON | Momentary Type ATX Power Switching Connector |
| COM2 | On-board Serial Port-2 Connector | | |
| CN4 | On-board PS/2 Mouse Port Connector | | |

Table 2-6

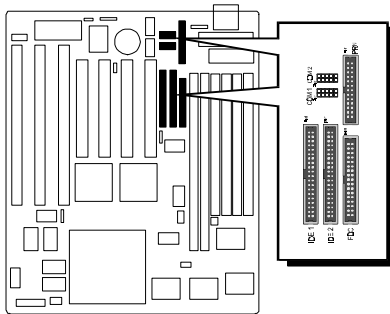

IDE, Floppy, Parallel and Serial port connectors

The main board shipped with one 40-pin ribbon cable for IDE H.D.D , one 34-pin ribbon cable for F.D.D, one 25-pin ribbon cable for printer and two 9-pin ribbon cable for COM port devices. Ribbon cables should always be connected with the red stripe on the Pin 1 side of the connector.

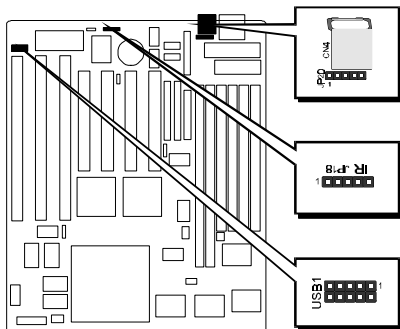

PS/2 Mouse connector

The main board provides a mini DIN connector or a 5 pins PS/2 mouse header for optional PS/2 mouse cable. Diagram on the right side indicates the pinout of the 5-pin header.

HOT-579 mainboard supplies two types of optional PS/2 mouse adapter cable, type 1 have 6-holes plug with hole 2 and hole 6 wireless; type 2 have 5-holes plug with hole 2 wireless.

Caution : When a PS/2 mouse is used, make sure connect PS/2 mouse adapter cable hole 1 to the pin 1 of onboard PS/2 connector (JP20). Reversed connecting may cause damage to your PS/2 mouse.

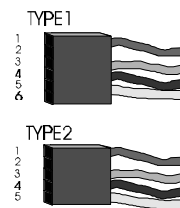

USB Connectors Pin-out

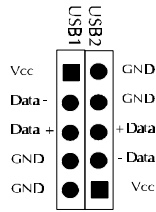

IR JP18



USB1, USB2 - USB connectors

The main board provides two sets USB (Universal Serial Bus) connectors - USB1 and USB2 for USB devices use.

JP18 - Infrared module connectors

The main board provides a 5-pin infrared and fast infrared connectors as an optional infrared module for wireless transmitting and receiving.

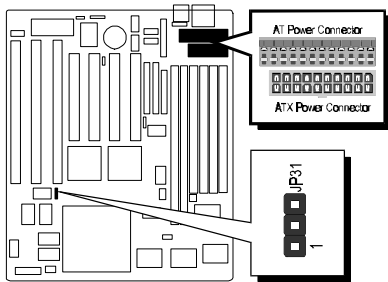

PWR ON - ATX Power Switch Button Connector

(Available only when ATX power supply is used).

The system power can be controlled by a momentary switch connector. Pushing the switch button will turn the system off .

Note:

When a AT Power Supply is used to HOT-579, please do not connect any momentary switch to PWR ON.

AT and ATX Power connectors

The main board provides both AT and ATX Power connector. ATX power supports soft power on/off function.

Jumper JP31 is used to set which type of power supply is used (Please also refer to page 11 **Power Supply Type Select**)

3

MEMORY CONFIGURATION

The HOT-579 mainboard provides four 72-pin SIMM sockets and two 168-pin DIMM sockets that make it possible to install up to 256MB of RAM. The SIMM socket support 4MB, 8MB, 16MB, 32MB, 64MB and 128MB 5V single- or double-side fast page or EDO DRAM modules, and DIMM socket support 8MB, 16MB, 32MB, 64MB, and 128MB 3.3V single- or double-side SDRAM, fast page, or EDO modules.

The four SIMM sockets are arranged in two banks of two sockets each, the two DIMM socket are arranged in two banks of one socket each. Each bank provides a 64/72-bit wide data path.

Note:

- Maximum memory size is 512MB total for all SIMM.**
- Maximum memory size is 256MB total for all DIMM.**
- If using SIMM modules, each bank must be filled with a pair of same modules.**
- The user should not populate both 5V SIMM modules & 3.3V DIMM modules at the same time.**

The memory configuration tables on next page list the SIMMs and DIMMs memory configuration.

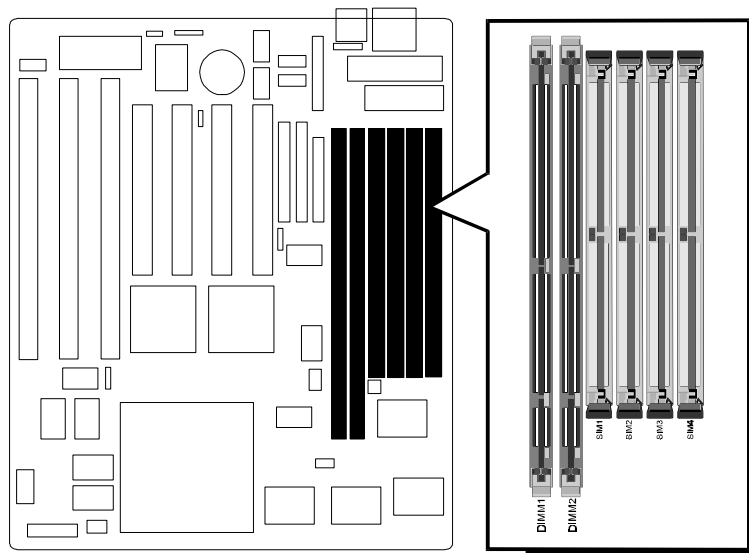

| SIM 1 | SIM 2 | SIM 3 | SIM 4 | DIM 1 | DIM 2 | TOTAL |
|--------|--------|--------|--------|--------|--------|--------|
| 4 MB | 4 MB | | | | | 8 MB |
| 4 MB | 4 MB | 4 MB | 4 MB | | | 16 MB |
| 8 MB | 8 MB | | | | | 16 MB |
| 4 MB | 4 MB | 8 MB | 8 MB | | | 24 MB |
| 8 MB | 8 MB | 8 MB | 8 MB | | | 32 MB |
| 16 MB | 16 MB | | | | | 32 MB |
| 4 MB | 4 MB | 16 MB | 16 MB | | | 40 MB |
| 8 MB | 8 MB | 16 MB | 16 MB | | | 48 MB |
| 16 MB | 16 MB | 16 MB | 16 MB | | | 64 MB |
| 32 MB | 32 MB | | | | | 64 MB |
| 4 MB | 4 MB | 32 MB | 32 MB | | | 72 MB |
| 8 MB | 8 MB | 32 MB | 32 MB | | | 80 MB |
| 16 MB | 16 MB | 32 MB | 32 MB | | | 96 MB |
| 32 MB | 32 MB | 32 MB | 32 MB | | | 128 MB |
| 64 MB | 64 MB | | | | | 128 MB |
| 4 MB | 4 MB | 64 MB | 64 MB | | | 136 MB |
| 8 MB | 8 MB | 64 MB | 64 MB | | | 144 MB |
| 16 MB | 16 MB | 64 MB | 64 MB | | | 160 MB |
| 32 MB | 32 MB | 64 MB | 64 MB | | | 192 MB |
| 64 MB | 64 MB | 64 MB | 64 MB | | | 256 MB |
| 128 MB | 128 MB | | | | | 256 MB |
| 128 MB | 128 MB | 128 MB | 128 MB | | | 512 MB |
| | | | | 8 MB | | 8 MB |
| | | | | 8 MB | 8 MB | 16 MB |
| | | | | 8 MB | 16 MB | 24 MB |
| | | | | 16 MB | | 16 MB |
| | | | | 16 MB | 16 MB | 32 MB |
| | | | | 16 MB | 32 MB | 48 MB |
| | | | | 32 MB | | 32 MB |
| | | | | 32 MB | 32 MB | 64 MB |
| | | | | 32 MB | 64 MB | 96 MB |
| | | | | 64 MB | | 64 MB |
| | | | | 64 MB | 64 MB | 128 MB |
| | | | | 64 MB | 128 MB | 192 MB |
| | | | | 128 MB | | 128 MB |
| | | | | 128 MB | 128 MB | 256 MB |

4

Flash Utility

This chapter briefly discusses Award Flash utility provides instructions to guide you through updating your old BIOS. The file name we use to program here is test.bin, and the file name to save old BIOS is 579.OLD. Please note that those file names are not absolute. They are only examples to let you have a more clear understanding of the updating process.

How to Begin

1. Please type "awdf flash" and press the **ENTER** key to begin the updating process.
2. Once you enter, you will see a main menu displaying:
3. Move the cursor to "File Name to Program:"
4. Type the program name "test.bin", and then press the ENTER key.
5. At the bottom of the menu, you will be requested to answer:

"Do You Want to Save BIOS (Y/N)? "

```
FLASH MEMORY WRITER v5.32B
Copyright (C) 1993, Award Software, Inc.,
For AMB-UP2-W83977B-205LCH29C DATE: 07/21/97
Flash Type - MXIC 28F1000AF /12U
File Name to Program : test.bin
Error Message: Are you sure to program (y/n)
```

The following manual is intended to guide you through the process of both "No" and "Yes" cases respectively.

If "No"

If you do not wish to save the old BIOS:

1. Please type "N", and then press the ENTER key.
2. Then you will be requested to answer:

"Are You Sure to Program? "

3. Answer ðNö if you do not want to program, and then it will exit.

```
FLASH MEMORY WRITER v5.32B
Copyright (C) 1993, Award Software, Inc.,
For AW8-UP2-4B3977B-Z85LCH29C DATE: 07/21/97
Flash Type - MXIC 28F1000AP /12U
File Name to Program : test.bin
File Name to Save : 579.ald
Error Message: Are you sure to program (y/n)
```

If "Yes"

To save the old BIOS:

1. Please respond "Y", and then press the ENTER key.
2. Move the cursor to "File Name to Save: "
3. Type file name "579.OLD", and then press the ENTER key. (Your old BIOS will be saved in the file name you create. In this case, the old BIOS is saved in the file name, 579.OLD).
4. Then you will be requested to answer:
"Are You Sure to Program (Y/N)? "
5. Type "Y" to begin programming, and press the ENTER key.
6. When the programming is finished, the showing message will appear:
7. Once you see the showing message "Power Off or Reset System", please restart your system.
8. When you power on the computer again, you will find your old BIOS has already been successfully updated.

To view a complete usage of FLASH utility, please type "awdf flash /?" and press the ENTER key.

Notes About Award Flash Utility

Please note that Award Flash Utility cannot run under EMM386 or QEMM. Thus, when executing the command "awdf flash", an error message will appear:

"Error Message: Fail ù Due to EMM386 or QEMM !"

5

BIOS SETUP

HOT-579 BIOS ROM has a built-in Setup program that allows users to modify the basic system configuration. This type of information is stored in battery-backed RAM so that it retains the Setup information when the power is turned off.

Entering Setup

Power on the computer and press immediately will allow you to enter Setup. The other way to enter Setup is to power on the computer, when the below message appear briefly at the bottom of the screen during the POST (Power On Self Test), press key or simultaneously press <Ctrl>,<Alt>, and <Esc> keys.

“TO ENTER SETUP BEFORE BOOT PRESS CTRL-ALT-ESC OR DEL KEY”

If the message disappears before you respond and you still wish to enter Setup, restart the system to try again by turning it OFF the ON or pressing the “RESET” button on the system case. You may also restart by simultaneously press <Ctrl>,<Alt>, and <Delete> keys. If you do not press the keys at the correct time and the system does not boot, an error message will be displayed and you will again be asked to,

“PRESS F1 TO CONTINUE, CTRL-ALT-ESC OR DEL TO ENTER SETUP”

Main Menu

| ROM PCI/ISA BIOS (ZASLDH2B) CMOS SETUP UTILITY AWARD SOFTWARE, INC. | |
|---|--------------------------|
| STANDARD CMOS SETUP | INTEGRATED PERIPHERALS |
| BIOS FEATURES SETUP | SUPERVISOR PASSWORD |
| CHIPSET FEATURES SETUP | USER PASSWORD |
| POWER MANAGEMENT SETUP | IDE HDD AUTO DETECTION |
| PNP/PCI CONFIGURATION | SAVE & EXIT SETUP |
| LOAD BIOS DEFAULTS | EXIT WITHOUT SAVING |
| LOAD SETUP DEFAULTS | |
| Esc : Quit | ↑ ↓ → ← : Select Item |
| F10 : Save & Exit Setup | (Shift)F2 : Change Color |

Standard CMOS setup

This setup page includes all items in a standard compatible BIOS.

BIOS features setup

This setup page includes all items of Award special enhanced features.

Chipset features setup

This setup page includes all items of chipset features.

Power Management Setup

This setup page includes all items of Power Management features.

PnP/PCI Configuration

This item specifies the value (in units of PCI bus blocks) of the latency timer for the PCI bus master and the IRQ level for PCI device. Power-on with BIOS defaults

Load BIOS Defaults

BIOS defaults loads the values required by the System for the maximum performance. However, you can change the parameter through each Setup Menu.

Load Setup Defaults

Setup defaults loads the values required by the system for the O.K. performance. However, you can change the parameter through each Setup Menu.

Integrated Peripherals

This setup page includes all items of peripheral features.

Supervisor Password

Change, set, or disable supervisor password. It allows you to limit access to the system and Setup, or just to Setup.

User Password

Change, set, or disable user password. It allows you to limit access to the system and Setup, or just to Setup.

IDE HDD auto detection

Automatically configure IDE hard disk drive parameters.

Save & Exit setup

Save CMOS value change to CMOS and exit setup

Exit without saving

Abandon all CMOS value changes and exit setup.

Standard CMOS Setup

```
ROM PCI/ISA BIOS (ZASLDH2B)
STANDARD CMOS SETUP
AWARD SOFTWARE, INC.

Date (mm:dd:yy) : Sat, Nov 4 1973
Time (hh:mm:ss) : 5 : 36 : 51

HARD DISKS      TYPE      SIZE  CYLS  HEAD  PRECOMP  LANDZ  SECTOR  MODE
-----
Primary Master  : Auto      0      0    0      0      0      0    AUTO
Primary Slave   : Auto      0      0    0      0      0      0    AUTO
Secondary Master : Auto      0      0    0      0      0      0    AUTO
Secondary Slave  : Auto      0      0    0      0      0      0    AUTO

Drive A : 1.44M, 3.5 in.
Drive B : Nonc

Video : EGA/UGA
Halt On : All Errors

Basic Memory : 0K
Extended Memory : 0K
Other Memory : 512K
-----
Total Memory : 512K

ESC : Quit      ↑ ↓ → ← : Select Item      PU/PD/+/- : Modify
F1  : Help      (Shift)F2 : Change Color
```

Date

The date format is <day>, <month> <date> <year>. Press <F3> to show the calendar.

Time

The time format is <hour> <minute> <second>. The time is calculated base on the 24-hour military-time clock. For example, 5 p.m. is 17:00:00.

Hard Disks Type

This item identify the types of hard disk drives that has been installed in the computer. There are 46 predefined types and a user definable type.

Press PgUp or PgDn to select a numbered hard disk type or type the number and press <Enter>. Note that the specifications of your drive must match with the drive table. The hard disk will not work properly if you enter improper information for this item. If your hard disk drive type is not matched or listed, you can use Type User to define your own drive type manually.

If you select Type User, related information is asked to be entered to the following items. Enter the information directly from the keyboard and press <Enter>. Those information should be provided in the documentation from your hard disk vendor or the system manufacturer.

The user may also set those items to AUTO to auto configure hard disk drives parameter when system power-on.

If a hard disk drive has not been installed select NONE and press <Enter>.

Drive A type/Drive B type

This item specifies the types of floppy disk drive A or drive B that has been installed in the system.

Video

This item selects the type of adapter used for the primary system monitor that must match your video display card and monitor. Although secondary monitors are supported, you do not have to select the type in Setup.

Error halt

This item determines if the system will stop, when an error is detected during power up.

Memory

This item is display-only. It is automatically detected by POST (Power On Self Test) of the BIOS.

Base Memory

The POST of the BIOS will determine the amount of base (or conventional) memory installed in the system. The value of the base memory is typically 512K for systems with 512K memory installed on the mainboard, or 640K for systems with 640K or more memory installed on the mainboard.

Extended Memory

The BIOS determines how much extended memory is present during the POST. This is the amount of memory located above 1MB in the CPU's memory address map.

BIOS Features Setup

| ROM PCI/ISA BIOS (ZASLDH2B) BIOS FEATURES SETUP AWARD SOFTWARE, INC. | | | |
|--|------------|--------------------------|--------------------|
| Virus Warning | : Disabled | Video BIOS Shadow | : Enabled |
| CPU Internal Cache | : Enabled | C8000-CBFFF Shadow | : Disabled |
| External Cache | : Enabled | CC000-CFFFF Shadow | : Disabled |
| Quick Power On Self Test | : Enabled | D0000-D3FFF Shadow | : Disabled |
| Boot Sequence | : A,C,SCSI | D4000-D7FFF Shadow | : Disabled |
| Swap Floppy Drive | : Disabled | D8000-DBFFF Shadow | : Disabled |
| Boot Up Floppy Seek | : Enabled | DC000-DFFFF Shadow | : Disabled |
| Boot Up NumLock Status | : Un | | |
| Boot Up System Speed | : High | | |
| Gate A20 Option | : Fast | | |
| Typematic Rate Setting | : Disabled | | |
| Typematic Rate (Chars/Sec) | : 6 | | |
| Typematic Delay (Msec) | : 250 | | |
| Security Option | : Setup | | |
| IDE Second Channel Control | : Enabled | | |
| PCI/UGA Palette Snoop | : Disabled | | |
| OS Select For DRAM > 64MB | : Non-OS2 | | |
| | | ESC : Quit | ↑↓←→ : Select Item |
| | | F1 : Help | PU/PD/+/- : Modify |
| | | F5 : Old Values (Shift) | F2 : Color |
| | | F6 : Load BIOS Defaults | |
| | | F7 : Load Setup Defaults | |

Virus Warning

When this item is enabled, the Award BIOS will monitor the boot sector and partition table of the hard disk drive for any attempt at modification. If an attempt is made, the BIOS will halt the system and the following error message will appear. Afterwards, if necessary, you will be able to run an anti-virus program to locate and remove the problem before any damage is done.

```
!WARNING!  
Disk boot sector is to be modified  
Type "Y" to accept write or "N" to abort write  
Award Software, Inc.
```

CPU Internal/External Cache

This item enables CPU internal cache and external cache to speed up memory access.

Quick Power On Self Test

This item speeds up Power On Self Test (POST) after you power on the computer. If it is set to Enabled, BIOS will shorten or skip some check items during POST.

Boot Sequence

This item determines which drive computer searches first for the disk operating system. Default setting is A, C, SCSI.

BIOS also support system boot from CD-ROM drive or SCSI hard disk drive.

Swap Floppy Drive

When this item enables, the BIOS will swap floppy drive assignments so that Drive A: will function as Drive B: and Drive B: as Drive A:.

Boot Up Floppy Seek

During POST, BIOS will determine if the floppy disk drive installed is 40 or 80 tracks.

Boot Up NumLock Status

When this option enables, BIOS turns on *Num Lock* when system is powered on.

Boot Up System Speed

This option sets the speed of CPU at system boot time. The settings are High or Low.

Gate A20 Option

This entry allows you to select how the gate A20 is handled. The gate A20 is a device used to address memory above 1 Mbytes. Initially, the gate A20 was handled via a pin on the keyboard. Today, while keyboards still provide this support, it is more common, and much faster, set to *Fast* for the system chipset to provide support for gate A20.

Typematic Rate Setting/Typematic Rate/Typematic Delay

This determines if the typematic rate and typematic delay are to be used. When the typematic rate setting is enabled, **typematic rate** allows you select the rate at which the keys are accelerated and **typematic delay** allows you to select the delay between when the key was first depressed and when the acceleration begins.

Security Option

This item allows you to limit access to the System and Setup, or just to Setup.

When *System* is selected, the System will not boot and access to Setup will be denied if the correct password is not entered at the prompt.

When *Setup* is selected, the System will boot, but access to Setup will be denied if the correct password is not entered at the prompt.

PCI / VGA Palette Snoop

This item must be set to enabled if there is a MPEG ISA card installed in the system, and disabled if there is no MPEG ISA card installed in the system.

OS Select For DRAM > 64MB

This item allows you to access the memory that over 64 MB in OS/2.

Video BIOS Shadow/XXXXX-XXXXX Shadow

These items determine whether Video BIOS or optional ROM will be copied to RAM.

Chipset Features Setup

| ROM PCI/ISA BIOS (ZASLDH2B) | |
|--|---------------------------------|
| CMOS SETUP UTILITY | |
| CHIPSET FEATURES SETUP | |
| DRAM Auto Configuration : Disabled | OnChip USB : Enabled |
| DRAM Timing Control : Normal | USB Keyboard Support : Disabled |
| SDRAM Cycle Length : 3 | |
| SDRAM Bank Interleave : Disabled | |
| Sustained 3T Write : Disabled | |
| 2 Bank PBSRAM : 3-1-1-1 | |
| Read Pipeline : Disabled | |
| Write Pipeline : Enabled | |
| Cache Timing : Fast | |
| Video BIOS Cacheable : Disabled | |
| System BIOS Cacheable : Disabled | |
| Memory Hole At 15Mb Addr.: Disabled | |
| ESC : Quit F10 : Select Item F1 : Help PU/PD/+/- : Modify F5 : Old Values (Shift)F2 : Color F6 : Load BIOS Defaults F7 : Load Setup Defaults | |

DRAM Auto Configuration

This item auto configures the item of DRAM Timing Control. **DRAM Timing Control** will be set to "Auto" when this item set to **60 ns** or **70 ns**. **DRAM Timing Control** may be set to "Normal", "Medium", "Fast" or "Turbo" when this item set to Disabled.

DRAM Timing Control

This item set the DRAM Read/Write timings that the system uses. The options are "Normal", "Medium", "Fast", "Turbo" or "Disabled".

SDRAM Cycle Length

This field sets the CAS latency timing.

The Choice: 2, 3.

SDRAM Bank Interleave

This item allows you to set how many banks of SDRAM support in your mainboard.

The Choice: 2 Bank, 4 Bank, Disabled.

Sustained 3T Write

This item allow you to enable or disable direct map write back / write through secondary cache.

The Choice: Enabled, Disabled.

2 Bank PBSRAM

This item allows the user to set 2 Bank PBSAM timing. The options are 3-1-1-1 and 2-1-1-1.

This item only affect to 1MB Cache.

Read Pipeline

You may select Enabled for this field when PBSRAMs are installed. Pipelining improves system performance.

The Choice: Enabled, Disabled.

Write Pipeline

You may select Enabled for this field when PBSRAMs are installed. Pipelining improves system performance.

The Choice: Enabled, Disabled.

Cache Timing

This item allows the user to set the cache timing. The options are Fast and Fastest.

Video BIOS Cacheable

This item allows the user to set the video BIOS C000~C7FF areas that are cacheable or non-cacheable.

System BIOS Cacheable

This item allows the user to set the system BIOS F000~FFFF areas that are cacheable or non-cacheable.

Memory Hole At 15b Addr

In order to improve performance, some space in memory can be reserved for ISA cards. This memory must be mapped into the memory space below 16 MB.

OnChip USB

This item is used to defined USB controller is “*Enable*” or “*Disable*”.

USB Keyboard Support

This item is used to defined USB Keyboard is “*Enable*” or “*Disable*”.

Power Management Setup

| ROM PCI/ISA BIOS (ZASLDH2B) | |
|-----------------------------------|-----------------------------------|
| POWER MANAGEMENT SETUP | |
| AWARD SOFTWARE, INC. | |
| Power Management : Disable | Primary INTR : ON |
| PM Control by APM : Yes | IRQ3 (COM 2) : Primary |
| Video Off Option : Suspend -> Off | IRQ4 (COM 1) : Primary |
| Video Off Method : U/H SYNC+Blank | IRQ5 (LPT 2) : Primary |
| Conserve Mode : Disabled | IRQ6 (Floppy Disk) : Primary |
| MODEM Use IRQ : 3 | IRQ7 (LPT 1) : Primary |
| Soft-Off by PWRBTN : Instant-Off | IRQ8 (RTC Alarm) : Disabled |
| ** PM Timers ** | IRQ9 (IRQ2 Redir) : Secondary |
| HDD Power Down : Disable | IRQ10 (Reserved) : Secondary |
| Doze Mode : Disable | IRQ11 (Reserved) : Secondary |
| Suspend Mode : Disable | IRQ12 (PS/2 Mouse) : Primary |
| ** PM Events ** | IRQ13 (Coprocessor) : Primary |
| UGA : OFF | IRQ14 (Hard Disk) : Primary |
| LPT & COM : LPT/COM | IRQ15 (Reserved) : Disabled |
| HDD & FDD : ON | ESC : Quit |
| DMA/master : OFF | F1 : Help |
| Modem Ring Resume : Disabled | F5 : Old Values (Shift)F2 : Color |
| RTC Alarm Resume : Disabled | F6 : Load BIOS Defaults |
| | F7 : Load Setup Defaults |
| | ↑↓←→ : Select Item |
| | PU/PD/+/- : Modify |

Power Management

This item determines the options of the power management function. *Max Saving* puts the system into power saving mode after a brief period of system inactivity; *Min Saving* is the same as *Max Saving* except the time of the system inactivity period is longer; *Disabled* disables the power saving feature; *User Defined* allows you to set power saving options according to your preference.

PM Control by APM

If this item set to No, system BIOS will be ignored and APM calls the power to manage the system.

If this item setup to Yes, system BIOS will wait for APM's prompt before it enter any PM mode e.g. *DOZE*, *STANDBY* or *SUSPEND*.

Video Off Option

When enabled, this features allows the VGA adapter to operate in a power saving mode.

Always On : Monitor will remain on during power saving modes.

Suspend-->Off : Monitor blanked when the systems enters the Suspend mode.

Susp, Stby-->Off : Monitor blanked when the system enters either Suspend or Standby modes.

All Modes-->Off : Monitor blanked when the system enters any power saving mode.

Video Off Method

This determines the manner in which the monitor is blanked.

V/H SYNC+Blank This selection will cause the system to turn off the vertical and horizontal synchronization ports and write blanks to the video buffer.

Blank Screen This option only writes blanks to the video buffer.

DPMS Allows the BIOS to control the video display card if it supports the DPMS feature.

Conserve Mode

This item allows you to enable/disable the Conserve Mode.

The choice: Enabled, Disabled.

MODEM Use IRQ

This determines the IRQ in which the MODEM can use.

The choice: 1,3, 4, 5, 7, 9, 10, 11, NA.

Soft-Off by PWRBTN

When Enabled, turning the system off with the on/off button places the system in a very low-power-usage state, with only enough circuitry receiving power to detect power button activity or Resume by Ring activity.

The choice: Delay 4 Sec, Instant Off.

HDD Power Down

This item defines the continuous HDD idle time before the HDD enters power saving mode (motor off). The options are from 1 min to 15 min and *Disabled*.

Doze Mode, Suspend Mode

These items set the period of time after which each of these mode activate, the periods are from 1 min to 1 hour.

Doze Mode When enabled and after the set time of system inactivity, CPU clock will run at slower speed while all other devices still operate at full speed.

Suspend Mode When enabled and after the set time of system inactivity, all devices except CPU will be shut off.

**** PM Events ****

If these items is set to Disabled, the system activity event will not be monitored to reload global timer.

If these items is set to Enabled, the system activity event will be monitored to reload global timer.

These items including VGA, LPT & COM, HDD & FDD, DMA/master, RTC Alarm Resume, Primary INTR and IRQ[3-15].

PCI Configuration Setup

| ROM PCI/ISA BIOS (ZASLDH2B) PNP/PCI CONFIGURATION AWARD SOFTWARE, INC. | |
|--|--|
| PNP OS Installed : No | CPU to PCI Write Buffer : Enabled |
| Resources Controlled By : Manual | PCI Dynamic Bursting : Enabled |
| Reset Configuration Data : Disabled | PCI Master 0 WS Write : Enabled |
| IRQ-3 assigned to : Legacy ISA | |
| IRQ-4 assigned to : Legacy ISA | |
| IRQ-5 assigned to : PCI/ISA PnP | PCI IRQ Activated By : Level |
| IRQ-7 assigned to : PCI/ISA PnP | PCI IDE IRQ Map To : PCI-AUTU |
| IRQ-9 assigned to : PCI/ISA PnP | Primary IDE INT# : A |
| IRQ-10 assigned to : PCI/ISA PnP | Secondary IDE INT# : B |
| IRQ-11 assigned to : PCI/ISA PnP | |
| IRQ-12 assigned to : PCI/ISA PnP | MS IRQ Routing Table : DISABLE |
| IRQ-14 assigned to : PCI/ISA PnP | |
| IRQ-15 assigned to : PCI/ISA PnP | ACPI I/O Device Mode : Enabled |
| DMA-0 assigned to : PCI/ISA PnP | |
| DMA-1 assigned to : PCI/ISA PnP | ESC : Quit F10+ : Select Item |
| DMA-3 assigned to : PCI/ISA PnP | F1 : Help PU/PD/+/- : Modify |
| DMA-5 assigned to : PCI/ISA PnP | F5 : Old Values (Shift)F2 : Color |
| DMA-6 assigned to : PCI/ISA PnP | F6 : Load BIOS Defaults |
| DMA-7 assigned to : PCI/ISA PnP | F7 : Load Setup Defaults |

PNP OS Installed

When this item is set to Yes, it will allow the PnP OS(Windows 95) control the system resources except PCI devices and PnP boot devices.

Default setting is *No*.

Resources Controlled By

The Award Plug and Play BIOS has the capability to automatically configure all of the boot and Plug and Play compatible devices. However, this capability means absolutely nothing unless you are using a Plug and Play operating system as Windows 95.

Reset Configuration Data

This item allows you to determine whether to reset the configuration data or not.

IRQ 3/4/5/7/9/10/11/12/14/15, assigned to

These items allow you to determine the IRQ assigned to the ISA bus and is not available for PCI slot.

Choices are *Legacy ISA* and *PCI/ISA PnP*.

DMA 0/1/3/5/6/7 assigned to

These items allow you to determine the DMA assigned to the ISA bus and is not available for PCI slot.

Choices are *Legacy ISA* and *PCI/ISA PnP*.

CPU to PCI Write Buffer

When enabled, up to four words of data can be written to the PCI bus without interrupting the CPU. When disabled, a write buffer is not used and the CPU read cycle will not be completed until the PCI bus signals that it is ready to receive the data..

The choice: Enabled, Disabled.

PCI Dynamic Bursting

When Enabled, data transfers on the PCI bus, where possible, make use of the high-performance PCI burst protocol, in which greater amounts of data are transferred at a single command..

The choice: Enabled, Disabled.

PCI Master 0 WS Write

When Enabled, writes to the PCI bus are command with zero wait states.

The choice: Enabled, Disabled.

PCI IRQ Activated by

This item sets the method by which the PCI bus recognize that an IRQ service is being requested by a device. You should never change the default configuration unless advised otherwise by your System's manufacturer. Choices are *Level* (default) and *Edge*.

PCI IDE IRQ Map to

This items allows you to configure your system to the type of IDE disk controller in use. By default, Setup assumes that your controller is an ISA device rather than a PCI controller.

If you have equipped your system with a PCI controller, changing this allows you to specify which slot has the controller and which PCI interrupt (A, B, C or D) is associated with the connected hard drives.

Remember that this setting refers to the hard disk drive itself, rather than individual partitions. Since each IDE controller supports two separate hard disk drives, you can select the INT# for each. Again, you will note that the primary has a lower interrupt than the secondary as described in "*Slot x Using INT#*" above.

Selecting "*PCI Auto*" allows the system to automatically determine how your IDE disk system is configured.

MS IRQ Routing Table

This item allows the user to set BIOS IRQ Routing table Enabled or Disabled.

ACPI I/O Device Node

This item allows the user to set ACPI I/O Device Node Enabled or Disabled.

Integrated Peripherals

| ROM PCI/ISA BIOS (ZASLDH2B) INTEGRATED PERIPHERALS AWARD SOFTWARE, INC. | |
|---|------------------------------------|
| OnChip IDE First Channel : Enabled | Parallel Port Mode : ECP+EPP |
| OnChip IDE Second Channel : Enabled | ECP Mode Use DMA : 3 |
| IDE Prefetch Mode : Disabled | |
| IDE HDD Block Mode : Enabled | |
| IDE Primary Master PIO : Auto | |
| IDE Primary Slave PIO : Auto | |
| IDE Secondary Master PIO : Auto | |
| IDE Secondary Slave PIO : Auto | |
| IDE Primary Master UDMA : Auto | |
| IDE Primary Slave UDMA : Auto | |
| IDE Secondary Master UDMA : Auto | |
| IDE Secondary Slave UDMA : Auto | |
| Onboard FDC Controller : Enabled | |
| Onboard Serial Port 1 : 3F8/IRQ4 | |
| Onboard Serial Port 2 : 2F8/IRQ3 | |
| IR Address Select : 3E8H | ESC : Quit ↑↓←→ : Select Item |
| IR Mode : ASKIR | F1 : Help PU/PD/+/- : Modify |
| IR IRQ Select : IRQ10 | F5 : Old Values (Shift)F2 : Color |
| Onboard Parallel Port : 378/IRQ7 | F6 : Load BIOS Defaults |
| | F7 : Load Setup Defaults |

OnChip IDE First Channel

This item is used to defined on chip Primary PCI IDE controller is Enable or Disable setting.

OnChip IDE Second Channel

This item is used to defined on chip secondary PCI IDE controller is Enable or Disable setting.

IDE Prefetch Mode

Enable prefetching for IDE drive interfaces that support its faster drive accesses. If you are getting disk drive errors, change the setting to omit the drive interface where the errors occur. Depending on the configuration of your IDE subsystem, this field may not appear, and it does not appear when the Internal PCI/IDE field, above, is Disabled.

The choice: Enabled, Disabled.

IDE HDD Block Mode

This item is used to set IDE HDD Block Mode. If your IDE Hard Disk supports block mode, then you can enable this function to speed up the HDD access time. If not, please disable this function to avoid HDD access error.

IDE Primary/Secondary Master/Slave PIO

In these items, there are five modes defined in manual mode and one automatic mode. There are 0, 1, 2, 3, 4, and AUTO is the default settings for on board Primary/Secondary Master/Slave PIO timing.

IDE Primary/Secondary Master/Slave UDMA

On this mainboard, Intel 430TX PCIset improves IDE transfer rate using Bus Master UltraDMA/33 IDE which can handle data transfer up to 33MB/sec. The options are Disabled and Enabled, and Enabled is the default settings for on board Primary/Secondary Master/Slave UltraDMA33.

Onboard FDC Controller

This item specifies onboard floppy disk drive controller. This setting allows you to connect your floppy disk drives to the onboard floppy connector. Choose the "Disabled" settings if you have a separate control card.

Onboard Serial Port 1/2

This item is used to define onboard serial port 1/Port2 to *3F8/IRQ4, 2F8/IRQ3, 3E8/IRQ4, 2E8/IRQ3, Auto* or *Disabled*.

IR Address Select

This item is used to define onboard serial port 1/Port2 to *3F8/IRQ4, 2F8/IRQ3, 3E8/IRQ4, 2E8/IRQ3, Auto* or *Disabled*.

IR Mode

The main board support IrDA(HPSIR) and Amplitudes Shift Keyed IR(ASKIR) infrared through COM2 port. When IR is enable, the onboard COM2 port will be disabled. This item specifies onboard Infra Red mode to *IrDA 1.0, ASKIR, MIR 0.57M, MIR 1.15M, FIR* or *Standard (Disabled)*.

Note : FIR is not supported currently.

IR IRQ Select

This item is used to set IR Interrupt Request Line.

Onboard Parallel Port

This item specifies onboard parallel port address to *378H, 278H, 3BCH* or *Disabled*.

Parallel Port Mode

This item specifies onboard parallel port mode. The options are *SPP* (Standard Parallel Port), *EPP* (Enhanced Parallel Port), *ECP* (Extended Capabilities Port), and *EPP+ECP*.

ECP Mode Use DMA

This item specifies *DMA* (Direct Memory Access) channel when ECP device is in use. The options are *DMA 1* and *DMA 3*. This item will not show up when SPP and EPP printer mode is selected.

Password Setting

This section describes the two access modes that can be set using the options found on the Supervisor Password and User Password.

| ROM PCI/ISA BIOS (2A59GH2B) CMOS SETUP UTILITY AWARD SOFTWARE, INC. | |
|---|--|
| STANDARD CMOS SETUP | INTEGRATED PERIPHERALS |
| BIOS FEATURES SETUP | IDE HDD AUTO DETECTION |
| CHIPSET FEATURES SETUP | <u>SUPERVISOR PASSWORD</u> |
| POWER MANAGEMENT SETUP | USER PASSWORD |
| PNP/PCI CONFIGURATION | SAVE & EXIT SETUP |
| LOAD BIOS DEFAULTS | Enter Password: <input type="text"/> UT SAVING |
| LOAD SETUP DEFAULTS | |
| Esc : Quit | ↑ ↓ → ← : Select Item |
| F10 : Save & Exit Setup | (Shift)F2 : Change Color |
| Change/Set/Disable Password | |

Supervisor Password and User Password

The options on the Password screen menu make it possible to restrict access to the Setup program by enabling you to set passwords for two different access modes: Supervisor mode and User mode.

In general, Supervisor mode has full access to the Setup options, whereas User mode has restricted access to the options. By setting separate Supervisor and User password, a system supervisor can limit who can change critical Setup values.

Enter Password

Type the password, up to eight characters, and press <Enter>. The password typed now will clear any previously entered password from CMOS memory. You will be asked to confirm the password. Type the password again and press <Enter>. You may also press <Esc> to abort the selection and not enter a password.

To disable password, just press <Enter> when you are prompted to enter password. A message will confirm the password being disabled. Once the password is disabled, the system will boot and you can enter Setup freely.

Password Disable

If you select System at Security Option of BIOS Features Setup Menu, you will be prompted for the password every time the system is rebooted or any time you try to enter Setup. If you select Setup at Security Option of BIOS Features Setup Menu, you will be prompted only when you try to enter Setup.

Warning : Retain a record of your password in a safe place. If you forget the password, the only way to access the system is to clear CMOS memory, please refer to "Clear CMOS".